

# TASCAM

# DR-60DMKII

Linear PCM Recorder

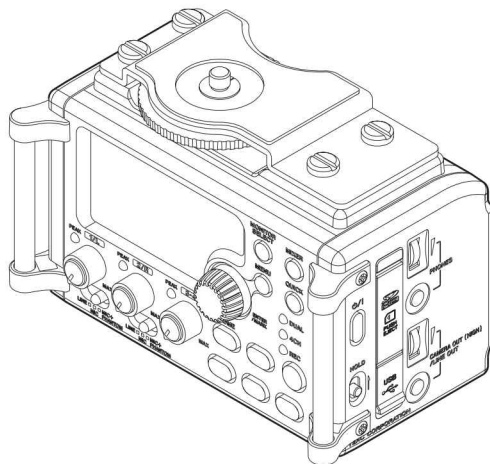

D01230700C

OWNER'S MANUAL

ENGLISH

MODE D'EMPLOI

FRANÇAIS

MANUAL DEL USUARIO

ESPAÑOL

BEDIENUNGSANLEITUNG

DEUTSCH

MANUALE DI ISTRUZIONI

ITALIANO

取扱説明書

日本語

- TASCAM is a registered trademark of TEAC Corporation.
- SDHC Logo is a trademark of SD-3C, LLC.



- Microsoft, Windows and Windows Vista are either registered trademarks or trademarks of Microsoft Corporation in the United States and/or other countries.
- Apple, Macintosh, iMac, Mac OS and Mac OS X are trademarks of Apple Inc.
- Other company names, product names and logos in this document are the trademarks or registered trademarks of their respective owners.

#### TEAC CORPORATION

<https://tascam.jp/jp/>

1-47 Ochiai, Tama-shi, Tokyo 206-8530 Japan

---

#### TEAC AMERICA, INC.

<https://tascam.com/us/>

Phone: +1-323-726-0303

10410 Pioneer Blvd. Suite #1 and #4, Santa Fe Springs, California 90670, U.S.A.

---

#### TEAC UK Ltd.

<https://tascam.eu/>

Phone: +44-1923-797205

Meridien House, 69-71 Clarendon Road, Watford, Herts, WD17 1DS, United Kingdom

---

#### TEAC EUROPE GmbH

<https://tascam.de/>

Phone: +49-611-71580

Bahnstrasse 12, 65205 Wiesbaden-Erbenheim, Germany

---

#### TEAC SALES & TRADING(SHENZHEN) CO., LTD

<http://tascam.cn/>

Phone: +86-755-88311561~2

Room 817, Xinian Center A, Tairan Nine Road West, Shenan Road, Futian District, Shenzhen, Guangdong Province 518040, China

---

# Owner's Manual

## IMPORTANT SAFETY PRECAUTIONS

### For U.S.A.

#### INFORMATION TO THE USER

This equipment has been tested and found to comply with the limits for a Class B digital device, pursuant to Part 15 of the FCC Rules. These limits are designed to provide reasonable protection against harmful interference in a residential installation. This equipment generates, uses, and can radiate radio frequency energy and, if not installed and used in accordance with the instruction manual, may cause harmful interference to radio communications. However, there is no guarantee that interference will not occur in a particular installation. If this equipment does cause harmful interference to radio or television reception, which can be determined by turning the equipment off and on, the user is encouraged to try to correct the interference by one or more of the following measures.

- a) Reorient or relocate the receiving antenna.
- b) Increase the separation between the equipment and receiver.
- c) Connect the equipment into an outlet on a circuit different from that to which the receiver is connected.
- d) Consult the dealer or an experienced radio/TV technician for help.

#### CAUTION

Changes or modifications to this equipment not expressly approved by TEAC CORPORATION for compliance could void the user's authority to operate this equipment.

### For Canada

THIS CLASS B DIGITAL APPARATUS COMPLIES WITH CANADIAN ICES-003.  
CET APPAREIL NUMERIQUE DE LA CLASSE B EST CONFORME A LA NORME  
NMB-003 DU CANADA.

#### Declaration of Conformity

Model Number : DR-60DMKII  
Trade Name : TASCAM  
Responsible party : TEAC AMERICA, INC.  
Address : 10410 Pioneer Blvd. Suite #1 and #4, Santa Fe Springs,  
California 90670, U.S.A.  
Telephone number : 1-323-726-0303

This device complies with Part 15 of the FCC Rules. Operation is subject to the following two conditions: (1) this device may not cause harmful interference, and (2) this device must accept any interference received, including interference that may cause undesired operation.

#### DECLARATION OF CONFORMITY

We, TEAC EUROPE GmbH, Bahnstrasse 12, 65205 Wiesbaden-Erbenheim, Germany declare in own responsibility, the TEAC product described in this manual is in compliance with the corresponding technical standards.



## IMPORTANT SAFETY INSTRUCTIONS

- 1 Read these instructions.
- 2 Keep these instructions.
- 3 Heed all warnings.
- 4 Follow all instructions.
- 5 Do not use this apparatus near water.
- 6 Clean only with dry cloth.
- 7 Do not block any ventilation openings. Install in accordance with the manufacturer's instructions.
- 8 Do not install near any heat sources such as radiators, heat registers, stoves, or other apparatus (including amplifiers) that produce heat.
- 9 Do not defeat the safety purpose of the polarized or grounding-type plug. A polarized plug has two blades with one wider than the other. A grounding type plug has two blades and a third grounding prong. The wide blade or

the third prong are provided for your safety. If the provided plug does not fit into your outlet, consult an electrician for replacement of the obsolete outlet.

- 10 Protect the power cord from being walked on or pinched particularly at plugs, convenience receptacles, and the point where they exit from the apparatus.
  - 11 Only use attachments/accessories specified by the manufacturer.
  - 12 Use only with the cart, stand, tripod, bracket, or table specified by the manufacturer, or sold with the apparatus. When a cart is used, use caution when moving the cart/apparatus combination to avoid injury from tip-over.
  - 13 Unplug this apparatus during lightning storms or when unused for long periods of time.
  - 14 Refer all servicing to qualified service personnel. Servicing is required when the apparatus has been damaged in any way, such as power-supply cord or plug is damaged, liquid has been spilled or objects have fallen into the apparatus, the apparatus has been exposed to rain or moisture, does not operate normally, or has been dropped.
- The apparatus draws nominal non-operating power from the AC outlet with its POWER or STANDBY/ON switch not in the ON position.
  - The mains plug is used as the disconnect device, the disconnect device shall remain readily operable.
  - Caution should be taken when using earphones or headphones with the product because excessive sound pressure (volume) from earphones or headphones can cause hearing loss.
  - If you are experiencing problems with this product, contact TEAC for a service referral. Do not use the product until it has been repaired.



## CAUTION

- Do not expose this apparatus to drips or splashes.
- Do not place any objects filled with liquids, such as vases, on the apparatus.
- Do not install this apparatus in a confined space such as a book case or similar unit.
- The apparatus should be located close enough to the AC outlet so that you can easily grasp the power cord plug at any time.

- If the product uses batteries (including a battery pack or installed batteries), they should not be exposed to sunshine, fire or excessive heat.
- CAUTION for products that use replaceable lithium batteries: there is danger of explosion if a battery is replaced with an incorrect type of battery. Replace only with the same or equivalent type.

## CAUTIONS ABOUT BATTERIES

This product uses batteries. Misuse of batteries could cause a leak, rupture or other trouble. Always abide by the following precautions when using batteries.

- Never recharge non-rechargeable batteries. The batteries could rupture or leak, causing fire or injury.
- When installing batteries, pay attention to the polarity indications (plus/minus (+/-) orientation), and install them correctly in the battery compartment as indicated. Putting them in backward could make the batteries rupture or leak, causing fire, injury or stains around them.
- When you store or dispose batteries, isolate their terminals with insulation tape or something like that to prevent them from contacting other batteries or metallic objects.
- When throwing used batteries away, follow the disposal instructions indicated on the batteries and the local disposal laws.
- Do not use batteries other than those specified. Do not mix and use new and old batteries or different types of batteries together. The batteries could rupture or leak, causing fire, injury or stains around them.
- Do not carry or store batteries together with small metal objects. The batteries could short, causing leak, rupture or other trouble.
- Do not heat or disassemble batteries. Do not put them in fire or water. Batteries could rupture or leak, causing fire, injury or stains around them.
- If the battery fluid leaks, wipe away any fluid on the battery case before inserting new batteries. If the battery fluid gets in an eye, it could cause loss of eyesight. If fluid does enter an eye, wash it out thoroughly with clean water without rubbing the eye and then consult a doctor immediately. If the fluid gets on a person's body or clothing, it could cause skin injuries or burns. If this should happen, wash it off with clean water and then consult a doctor immediately.
- The unit power should be off when you install and replace batteries.
- Remove the batteries if you do not plan to use the unit for a long time. Batteries could rupture or leak, causing fire, injury or stains around them. If the

battery fluid leaks, wipe away any fluid on the battery compartment before inserting new batteries.

- Do not disassemble a battery. The acid inside the battery could harm skin or clothing.

## ■ For European Customers

### Disposal of electrical and electronic equipment

- All electrical and electronic equipment should be disposed of separately from the municipal waste stream via designated collection facilities appointed by the government or the local authorities.
- By disposing of the electrical and electronic equipment correctly, you will help save valuable resources and prevent any potential negative effects on human health and the environment.
- Improper disposal of waste equipment can have serious effects on the environment and human health as a result of the presence of hazardous substances in electrical and electronic equipment.
- The crossed out wheeled dust bin symbol indicates that electrical and electronic equipment must be collected and disposed of separately from household waste.
- The return and collection systems are available to the end users. For more detailed information about disposal of old electrical and electronic equipment, please contact your city office, waste disposal service or the shop where you purchased the equipment.



### Disposal of batteries and/or accumulators

- Waste batteries and/or accumulators should be disposed of separately from the municipal waste stream via designated collection facilities appointed by the government or the local authorities.
- By disposing of waste batteries and/or accumulators correctly, you will help save valuable resources and prevent any potential negative effects on human health and the environment.
- Improper disposal of waste batteries and/or accumulators can have serious effects on the environment and human health as a result of the presence of hazardous substances in batteries and/or accumulators.
- The crossed out wheeled dust bin symbol indicates that batteries and/or accumulators must be collected and disposed of separately from household waste.

If the battery or accumulator contains more than the specified values of lead (Pb), mercury (Hg), and/or cadmium (Cd) defined in the Battery Directive (2006/66/EC), then the chemical symbols for lead (Pb), mercury (Hg) and/or cadmium (Cd) will be indicated beneath the crossed out wheeled dust bin symbol.



**Pb, Hg, Cd**

- The return and collection systems are available to the end users. For more detailed information about disposal of waste batteries and/or accumulators, please contact your city office, waste disposal service or the shop where you purchased them.

---

## Contents

---

Introduction.....	6
Items included with this product.....	7
Precautions for placement and use .....	7
Beware of condensation .....	7
Cleaning the unit .....	7
Using the TEAC Global Site .....	7
User registration .....	7
About TASCAM customer support service.....	7
Names and Functions of Parts.....	8
Front panel.....	8
Left side panel.....	8
Right side panel.....	9
Rear panel.....	9
Top panel.....	9
Bottom Panel.....	9
Home Screen .....	10
Preparation .....	11
Powering the unit.....	11
Starting up the unit.....	11
Setting the built-in clock.....	11
Shutting down (putting the unit in standby).....	11
Inserting SD cards.....	12
Camera connection and attachment.....	12
Connecting monitors and headphones.....	12
Basic operation procedures .....	13
Menu structure.....	13
Recording .....	13
Recording Screen .....	13
About recording standby.....	15
Menu structure.....	15
Adjusting the input level .....	15
Using the limiter .....	15
Using the low-cut filter .....	16
Overview of recording modes.....	16
Recording (MONO/STEREO recording).....	17
Playback .....	18
Adjusting the playback volume .....	18
Playback.....	18
Selecting files for playback (skipping) .....	18
Menu structure.....	18
Quick Operations.....	19
QUICK button overview .....	19
Connecting with a Computer .....	19
Connecting with a computer using USB.....	19
Exchanging files with a computer.....	19
Disconnecting from a computer.....	19
Settings and Information .....	19
System Settings .....	19
Quick reference for using various functions.....	20
Message.....	23
Troubleshooting .....	24
Specifications.....	25
Ratings.....	25
Inputs and outputs.....	25
Audio performance.....	25
Recording times.....	25
Requirements for connected computers.....	26
General .....	26

---

## Introduction

---

Thank you very much for purchasing the TASCAM DR-60DMKII Linear PCM Recorder.

Before connecting and using this unit, please take time to read this manual thoroughly to ensure you understand how to properly set it up and connect it, as well as the operation of its many useful and convenient functions.

After you have finished reading this manual, please keep it in a safe place for future reference.

This Owner's Manual explains the main functions of this unit.

Please see the Reference Manual for information about all the unit's functions.

You can also download this Owner's Manual and the Reference Manual from the TEAC Global Site (<http://teac-global.com/>).

---

## Items included with this product

---

This product includes the following items.

Take care when opening the package to avoid damaging the items. Keep the packing materials for transportation in the future.

Please contact the store where you purchased this unit if any of these items are missing or have been damaged during transportation.

- Main unit..... × 1
- USB cable..... × 1
- Owner's Manual (this manual) including warranty..... × 1

---

## Precautions for placement and use

---

- The environmental temperature operating range of this unit is 0–40°C (32–104°F).
- Do not install this unit in the following types of locations. Doing so could degrade the sound quality and/or cause malfunctions.
  - Places with significant vibrations
  - Near windows or other places exposed to direct sunlight
  - Near heaters or other extremely hot places
  - Extremely cold places
  - Places with bad ventilation or high humidity
  - Very dusty locations
  - Locations exposed directly to rain or other water
- Do not place this unit on top of a power amplifier or other device that generates heat.

- If this unit is placed near a power amplifier or other device with a large transformer, it could cause a hum. If this occurs, increase the distance between this unit and the other device.
- This unit could cause color irregularities on a TV screen or noise from a radio if used nearby. If this occurs, use this unit farther away.
- This unit might produce noise if a mobile phone or other wireless device is used nearby to make calls or send or receive signals. If this occurs, increase the distance between this unit and those devices or turn them off.

---

## Beware of condensation

---

If the unit is moved from a cold to a warm place, or used after a sudden temperature change, there is a danger of condensation; vapor in the air could condense on the internal mechanism, making correct operation impossible. To prevent this, or if this occurs, let the unit sit for one or two hours at the new room temperature before using it.

---

## Cleaning the unit

---

Use a dry soft cloth to wipe the unit clean. Do not wipe with chemical cleaning cloths, thinner, alcohol or other chemical agents. Doing so could damage the surface or cause discoloration.

---

## Using the TEAC Global Site

---

You can download updates for this unit from the TEAC Global Site:

<http://teac-global.com/>

In the TASCAM Downloads section, select the desired language to open the Downloads website page for that language.

---

## Product registration

---

Customers in the USA, please visit the following TASCAM website to register your TASCAM product online.

<https://tascam.com/us/>

---

## About TASCAM customer support service

---

TASCAM products are supported and warranted only in their country/region of purchase.

To receive support after purchase, on the TASCAM Distributors list page of the TEAC Global Site (<http://teac-global.com/>), search for the local company or representative for the region where you purchased the product and contact that organization.

When making inquiries, the address (URL) of the shop or web shop where it was purchased and the purchase date are required. Moreover, the warranty card and proof of purchase might also be necessary.

## Names and Functions of Parts

### Front panel

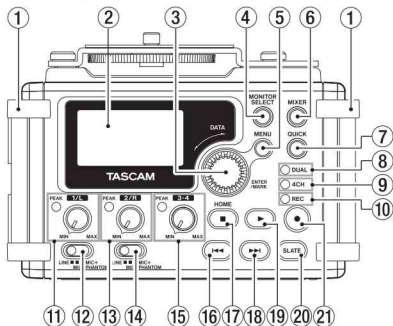

① **Handles**

Use this to attach a strap.

② **Display**

③ **DATA dial (ENTER/MARK)**

Use to select items and change values on the setting screens.

④ **MONITOR SELECT button**

⑤ **MENU button**

⑥ **MIXER button**

⑦ **QUICK button**

This opens the quick menu pop-up.

⑧ **DUAL indicator**

This lights orange when recording in dual recording mode.

⑨ **4CH indicator**

This lights orange when recording in 4-channel recording mode.

⑩ **REC indicator**

This blinks when in recording standby and lights red when recording.

⑪ **1/L knob and PEAK indicator**

⑫ **Input switch (1/L)**

⑬ **2/R knob and PEAK indicator**

⑭ **Input switch (2/R)**

⑮ **3-4 knob and PEAK indicator**

⑯ **⏪ button**

⑰ **Stop (■) [HOME] button**

⑱ **▶▶ button**

⑲ **▶ (playback) button**

⑳ **SLATE button**

Press and hold during playback to record a slate stone.

㉑ **● (record) button**

### Left side panel

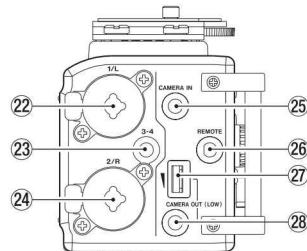

#### NOTE

*Do not apply excessive force when plugging in external devices to connect them to this unit or during use. In particular, be careful when using a standard-to-mini plug adapter, because the application of unintended force could result in damage to the device.*

㉒ **1/L connector (XLR/TRS)**

㉓ **3-4 connector (3.5mm stereo mini jack)**

㉔ **2/R connector (XLR/TRS)**

㉕ **CAMERA IN connector (3.5mm stereo mini jack)**

㉖ **REMOTE connector (2.5mm TRS jack)**

㉗ **CAMERA OUT (LOW) volume control**

㉘ **CAMERA OUT (LOW) connector (3.5mm stereo mini jack)**



## Right side panel

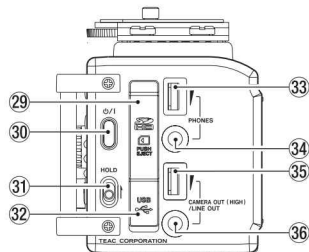

### NOTE

Do not apply excessive force when plugging in headphones and external devices to connect them to this unit or during use. In particular, be careful when using a standard-to-mini plug adapter, because the application of unintended force could result in damage to the device.

- 29 SD card slot
- 30 O/I button
- 31 HOLD switch
- 32 USB port
- 33 PHONES volume control
- 34 PHONES jack (3.5mm stereo mini jack)
- 35 CAMERA OUT (HIGH)/LINE OUT volume control
- 36 CAMERA OUT (HIGH)/LINE OUT jack (3.5mm stereo mini jack)

## Rear panel



- 37 Battery compartment cover

- 38 Battery compartment

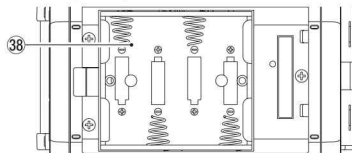

## Top panel

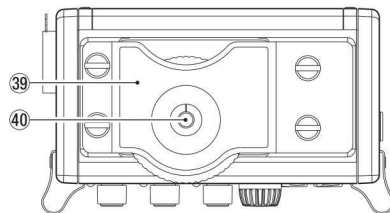

- 39 DSLR attachment bracket

- 40 DSLR mounting screw (1/4-inch)

## Bottom Panel

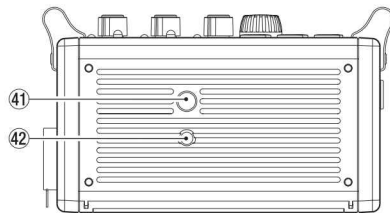

- 41 Tripod mounting threads (1/4-inch)

- 42 Video camera pin hole

## Home Screen

This is the screen that is usually shown when the unit is stopped.

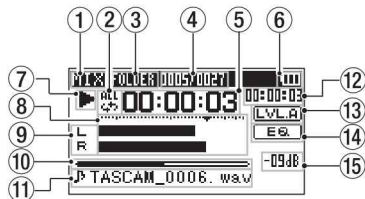

### CAUTION

When the monitoring function is on, some meters, icons and other items will change to recording screen appearance.

#### ① Monitoring mode

This shows what audio is now being monitored.

Indicator	Meaning
MIX	Mix of channels 1-4, or dual recording mode main file
SUB	Dual recording mode sub file
1+2	Mix of channels 1-2
3+4	Mix of channels 3-4
CAM	CAMERA IN jack sound input
CH1	Channel 1 sound input
1-M	Left channel of dual recording mode main file
1-S	Left channel of dual recording mode sub file

Indicator	Meaning
CH2	Channel 2 sound input
2-M	Right channel of dual recording mode main file
2-S	Right channel of dual recording mode sub file
CH3	Channel 3 sound input
3-M	Left channel of dual recording mode main file
3-S	Left channel of dual recording mode sub file
CH4	Channel 4 sound input
4-M	Right channel of dual recording mode main file
4-S	Right channel of dual recording mode sub file

#### ② Repeat playback setting

- Single playback
- Single file repeat playback
- All file repeat playback

#### ③ Playback area

- ALL: All files in the MUSIC folder
- FOLDER: All files in the selected folder

#### ④ Current playback file number/total number of files

This shows the current file number and total number of files in the current playback area.

#### ⑤ Elapsed time

This shows the elapsed time (hours: minutes: seconds) of the current file.

#### ⑥ Power supply status

When a battery is being used, a battery icon shows the amount of power remaining in bars .

The battery is almost dead and the power will soon turn off (standby) if the icon has no bars .

When using the TASCAM PS-P520E AC adaptor (sold separately) or USB bus power, appears.

#### ⑦ Recorder operation status

This icon shows the recorder operation status.

Indicator	Meaning
	Stopped
	Paused
	Playing back
	Searching forward
	Searching backward
	Skipping forward
	Skipping backward

#### ⑧ Level meter

These show the levels of the input and playback signals.

- ⑨ **Track status display**  
This icon changes according to the recording mode.

Indicators (examples)	Meaning
L R	Playing a file recorded in MONO or STEREO mode
CH 1 / CH 2 / CH 3 / CH 4	Monitoring in MONO mode
1-2 / 3-4	Monitoring in STEREO mode
CH 1 1-2 -E / -E	Playing a file recorded in DUAL MONO or DUAL ST mode or monitoring in these modes
1-2 3-4	Playing a file recorded in 4CH mode or monitoring in this mode

- ⑩ **Playback position display**  
The current playback position is shown by a bar.

- ⑪ **File name**  
This shows the name of the file playing back unless there are multiple files recorded in 4-channel recording mode or dual recording mode.

- ⑫ **Remaining time**  
This shows the elapsed time (hours: minutes: seconds) of the current file.

- ⑬ **Level align status**  
LVL.A : Level align function off  
LVL.A : Level align function on

- ⑭ **Playback equalizer status**  
EQ : Playback equalizer off  
EQ : Playback equalizer on

- ⑮ **Peak value in decibels (dB)**  
The maximum level that occurs in a fixed period of time is displayed digitally.

## Preparation

### Powering the unit

#### ■ Using AA batteries

1. Remove the battery compartment cover on the back of the unit.
2. Install 4 AA batteries with their ⊕ and ⊖ marks as shown in the battery compartment.
3. Close the battery compartment cover.

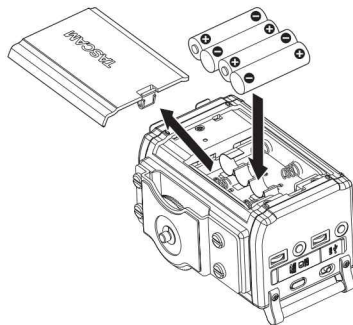

- Use the BATTERY TYPE item of the SYSTEM menu to set the type of battery in order to accurately show the amount of power remaining and allow the unit to accurately determine whether enough power is available for proper operation. (By default, this is set to ALKAL for alkaline batteries.)

## Starting up the unit

To start up the unit from the stopped state, press and hold the **⏻/I** button until "TASCAM DR-60DMKII" (start-up screen) is displayed on the display. The Home Screen appears when the unit starts up.



## Setting the built-in clock

When the unit is started up for the first time (or when the built-in clock is reset after being left unused without batteries), the DATE/TIME screen appears before the start-up screen to allow the date and time to be set.

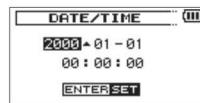

## Shutting down (putting the unit in standby)

Press and hold the **⏻/I** button until "LINEAR PCM RECORDER" appears on the display. The power turns off after the unit completes its shutdown (standby) process.

## Inserting SD cards

1. Open the SD card slot/USB port cover on the right side of the unit.
2. Insert the SD Card into the slot as shown in the following illustration until it clicks into place.

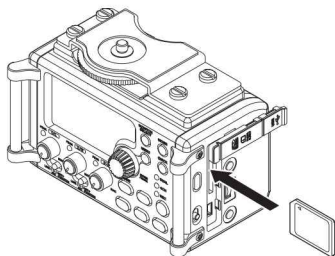

### NOTE

A list of SD cards that have been confirmed for use with this unit can be found on our web site. Please access to a product page of this product from the TASCAM Global Site (<http://teac-global.com>) to find the list or contact the TASCAM customer support service.

## Camera connection and attachment

In order to output the sound from this unit to a DSLR camera and monitor sound from the camera with this unit, you must connect them with commercially-available 3.5mm stereo mini plug cables.

1. If you want to record audio from this unit with a camera, connect the **CAMERA OUT (LOW)** jack on the left side of this unit with the external mic input on the camera.

If you want to input audio from the camera and monitor it with this unit, connect the **CAMERA IN** jack on the left side of this unit with the audio output jack on the camera.

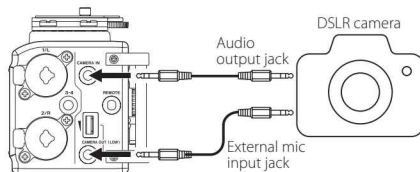

### NOTE

- If the output is not loud enough even when the **CAMERA OUT (LOW)** volume is set as high as possible, connect it to the **CAMERA OUT (HIGH)/LINE OUT** jack, and use the **CAMERA OUT (HIGH)/LINE OUT** volume to adjust the output level.
  - Refer to the camera's operation manual to identify this connector on the camera.
2. Use the **CAMERA OUT (LOW)** volume control on the left side of the unit to adjust the level output to the camera.
  3. To mount the camera on this unit, use the camera attachment screw on the top of the unit.

## Connecting monitors and headphones

To listen with headphones, connect them to the **PHONES** jack.

To listen with an external monitoring system (powered monitor speakers or an amplifier and speakers), connect it to the **CAMERA OUT (HIGH)/LINE OUT** jack.

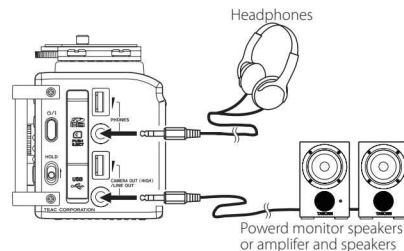

## Basic operation procedures

1. Press the **MENU** button to open the MENU Screen.

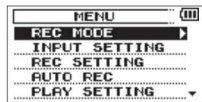

2. Turn the **DATA** dial to select a menu item (highlighted), and press the **DATA** dial or ►► button to move to various settings screens.
3. Turn the **DATA** dial to select a menu item (highlighted) to be set.
4. Press the **DATA** dial or ►► button to move the cursor to highlight the value of the setting.
5. Turn the **DATA** dial to change the setting.
6. Press the **DATA** dial or ◀◀ button to set a different item in the same menu.  
This enables you to select a new item. Turn the **DATA** dial again to select an item to be set.
7. Repeat step 3 to 6 as necessary to set each item.
8. To open the MENU screen (or OTHERS submenu screen), press the **MENU** button. To return to the Home Screen, press the **stop** (■) [**HOME**] button.

## Menu structure

### MENU

- REC MODE      Make recording settings
- INPUT SETTING      Make input settings
- REC SETTING      Make recording settings
- AUTO REC      Set the auto-recording function
- PLAY SETTING      Make playback settings
- BROWSE      Work with files and folders on the SD card
- OTHERS      Open the OTHERS submenu
  - INFORMATION      View information
  - FILE NAME      Make file name settings
  - DATE/TIME      Set the date and time
  - SYSTEM      Make system settings

## Recording

### Recording Screen

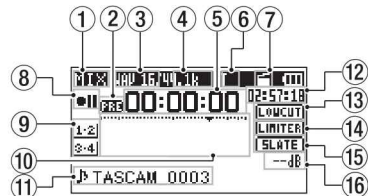

- 1 **Monitoring mode**  
This shows what audio is now being monitored.

Indicator	Meaning
MIX	Mix of channels 1-4, or dual recording mode main file
SUB	Dual recording mode sub file
1+2	Mix of channels 1-2
3+4	Mix of channels 3-4
CAM	<b>CAMERA IN</b> jack sound input
CH1	Channel 1 sound input
1-M	Left channel of dual recording mode main file
1-S	Left channel of dual recording mode sub file
CH2	Channel 2 sound input
2-M	Right channel of dual recording mode main file
2-S	Right channel of dual recording mode sub file

Indicator	Meaning
CH3	Channel 3 sound input
3-M	Left channel of dual recording mode main file
3-S	Left channel of dual recording mode sub file
CH4	Channel 4 sound input
4-M	Right channel of dual recording mode main file
4-S	Right channel of dual recording mode sub file

② **Prerecording or Auto recording function status**

 appears when the prerecording function is ON, and in recording standby.

 appears when the auto recording function is ON, and recording.

③ **Recording format**

This shows the file recording format.

WAV16, WAV24, BWF16 or BWF24

④ **Recording sampling frequency**

This shows the file recording sampling frequency.

44.1kHz, 48kHz or 96kHz

⑤ **Elapsed recording time**

The elapsed recording time of the file appears as hours: minutes: seconds.

⑥ **Number of recording channels**

This shows the number of recording channels in the file.

ST or MONO



⑦ **Auto tone function status**

No icon: Auto tone off

 Auto tone on





⑧ **Recorder operation status**

This icon shows the recorder operation status.

Indicator	Meaning
	Recording standby or Recording paused
	Recording
	Self-timer recording activated

⑨ **Input source**

This icon shows the input source.

Indicators (examples)	Meaning
	Mono recording mode input source
	Stereo recording mode input source
	Dual recording mode input source and gain setting for the second recording (0 to -12)
	4-channel recording mode input source

⑩ **Recording level meters**

The input signal level is shown.

⑪ **File name**

The file name that will automatically be given to the recorded file is shown.

⑫ **Remaining recording time**

The remaining recording time on the SD card is shown in hours: minutes: seconds according to the recording mode, sampling frequency and recording format settings.

⑬ **Low cut filter status**

 Low cut filter off

 Low cut filter on

⑭ **Limiter function status**

 Limiter off

 Limiter on

⑮ **SLATE button setting**

 SLATE button disabled

 SLATE button enabled

⑯ **Peak value in decibels (dB)**

Peak input level values are shown digitally.

## About recording standby

This unit has a recording standby function like that of a professional recorder. In recording standby mode, you can adjust the input level, for example, and then start recording quickly.

When in recording standby, the **REC** indicator blinks and the recording screen appears.

## Menu structure

You can make various settings with the **REC SETTING** item on the MENU screen.

### REC SETTING

FORMAT	Set the file format BWF: 16/24-bit, WAV: 16/24-bit
SAMPLE	Set the sampling frequency 44.1kHz, 48kHz, 96kHz
SIZE	Set the maximum file size 64MB, 128MB, 256MB, 512MB, 1GB, 2GB
SELF TMR	Set the self timer function OFF, 2sec, 10sec
MONITOR	Enabling monitoring OFF, ON

## Adjusting the input level

1. Press the **MENU** button to open the MENU screen.
2. Turn the **DATA** dial to select **INPUT SETTING**, and press the **DATA** dial or **▶▶1** button to open the **INPUT SETTING** screen.
3. Turn the **DATA** dial to set the **GAIN** for each channel, and press the **DATA** dial or **▶▶1** button.

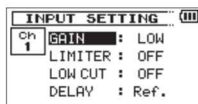

Ch1 INPUT SETTING screen

4. Turn the **DATA** dial to set the mic input gain. Options: MUTE, LOW (default value), MID, HIGH, HI+PLUS
5. When finished making the setting, press the **stop (■) [HOME]** button to return to the Home Screen.
6. Press the **record (●)** button to begin recording standby. The record indicator flashes red and the recording screen appears.



7. Use the **1/L**, **2/R** and **3-4** knobs on the front of the unit to adjust the input levels.

If the input levels are too high, the peak indicators to the left of the **1/L**, **2/R** and **3-4** knobs light red.

A **▼** mark is provided at -12dB on the level meters. Set the input level so that the indicator bars move to and fro with this mark at about the center without causing the **1/L** knob, **2/R** knob, **3-4** knob **PEAK** indicator to light red when the loudest sounds occur.

8. When finished making the setting, press the **stop (■) [HOME]** button to exit recording standby.

## Using the limiter

When the limiter is on, the mic input gain will be adjusted automatically according to the input level to set the recording level so that distortion does not occur even when loud sounds are input.

1. Press the **MENU** button to open the MENU screen.
2. Turn the **DATA** dial to select **INPUT SETTING**, and press the **DATA** dial or **▶▶1** button to open the **INPUT SETTING** screen.
3. Turn the **DATA** dial to select **LIMITER** for a channel, and press the **DATA** dial or **▶▶1** button.

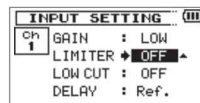

Ch1 INPUT SETTING screen

4. Turn the **DATA** dial to set the limiter for mic input.

Options	Meaning
OFF (default value)	Limiter off
MONO	Limiter on only for selected channel
LINK	Limiter on for both selected and linked channels

5. When finished making the setting, press the **stop** (■) [**HOME**] button to return to the Home Screen.

## Using the low-cut filter

Use the low-cut filter if you want to cut noise and other sounds at low frequencies. This function can be used to reduce air-conditioning noise and unpleasant wind noise, for example.

1. Press the **MENU** button to open the MENU screen.
2. Turn the **DATA** dial to select **INPUT SETTING**, and press the **DATA** dial or ►► button to open the **INPUT SETTING** screen. **INPUT SETTING** screen appears.
3. Turn the **DATA** dial to select **LOW CUT** for a channel, and press the **DATA** dial or ►► button.

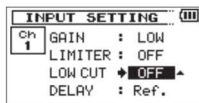

Ch1 INPUT SETTING screen

4. Turn the **DATA** dial to select the cut off frequency of the low cut filter for mic input. Options: OFF (default value), 40Hz, 80Hz, 120Hz
5. When finished making the setting, press the **stop** (■) [**HOME**] button to return to the Home Screen.

## Overview of recording modes

This recorder has five recording modes.

Use the **REC MODE** item on the **REC MODE** screen to set the recording mode. The settings available are different for each recording mode.

### MONO mode

This is a mode for mono recording.

### STEREO mode (default value)

This is a mode for stereo recording of two independent left and right channels.

### DUAL MONO mode

This mode uses one input source to create files at two different input levels (set on **INPUT SETTING** screen). Two mono files will be recorded.

### DUAL ST mode

This mode uses one input source to create files at two different input levels (set on **INPUT SETTING** screen). Two stereo files will be recorded.

### 4CH mode

This mode records 4 external inputs in two pairs as two stereo files.  
Two stereo files will be recorded.



## Recording (MONO/STEREO recording)

### ■ Make recording settings

1. Press the **MENU** button to open the MENU screen.
2. Turn the **DATA** dial to select REC MODE, and press the **DATA** dial or **▶▶I** button to open the REC MODE screen.  
REC MODE screen appears.
3. Turn the **DATA** dial to select REC MODE, and press the **DATA** dial or **▶▶I** button.
4. Turn the **DATA** dial to set it to MONO or STEREO (default value: STEREO).

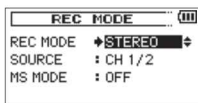

5. Press the **DATA** dial or **I◀◀** button to select the other item.
6. Turn the **DATA** dial to select SOURCE, and press the **DATA** dial or **▶▶I** button.
7. Turn the **DATA** dial to select the input source.

REC MODE	SOURCE (options)	Meaning
MONO	CH1	Channel 1 mono recording
	CH2	Channel 2 mono recording
	CH3	Channel 3 mono recording
	CH4	Channel 4 mono recording

REC MODE	SOURCE (options)	Meaning
STEREO	CH1/2	Channel 1 and 2 stereo recording
	CH3/4	Channel 3 and 4 stereo recording

8. Press the **DATA** dial or **I◀◀** button to select the other item.
9. If REC MODE is set to STEREO, you can also set MS mic decoding.  
To use a mid-side mic, turn the **DATA** dial to select MS MODE, and press the **DATA** dial or **▶▶I** button.
10. Turn the **DATA** dial to set the decoding mode when using a mid-side mic.

Options	Meaning
OFF	Record in ordinary stereo mode.
REC	Use to decode while recording. Playback is conducted without decoding.
MONITOR	Record mid-side mic output without decoding for decoding later. Use this mode to monitor when recording with a mid-side mic.
	Use this also when playing back mid-side files that were recorded without decoding.

11. When finished making the setting, press the **stop (■) [HOME]** button to return to the Home Screen.

### ■ Set where to save the file

1. Press the **MENU** button to open the MENU screen.

2. Turn the **DATA** dial to select BROWSE, and press the **DATA** dial or **▶▶I** button.  
BROWSE screen appears.
3. Select (highlight) the folder where you want to save the recorded file on the BROWSE screen, and press the **QUICK** button to open the quick menu pop-up.
4. Turn the **DATA** dial to select (highlight) SELECT, and press the **DATA** dial.
5. This sets the selected folder as the folder where recorded files are saved and reopens the Home Screen.

## ■ Starting the recording

1. Press the **record** (●) button to begin recording standby.  
The screen shows the recording file name, the input source, the recording audio file type and sampling frequency. Please confirm that these are as desired before starting recording.
2. To start recording, press the **record** (●) button again.



When recording starts, the **REC** indicator lights continuously, and the display shows the elapsed recording time and the remaining recording time.

3. Press the **stop** (■) [**HOME**] button to end recording and create the audio file.  
To pause recording, press the **record** (●) button. Press the **record** (●) button or play (▶) button again to restart recording in the same file.  
If you press the **stop** (■) [**HOME**] button after playing a recorded audio file up to the moment that you paused recording is created.

## Playback

### Adjusting the playback volume

Use the **PHONES** and **CAMERA OUT (HIGH)/LINE OUT** volume controls to adjust the levels output from the **PHONES** and **CAMERA OUT (HIGH)/LINE OUT** jacks.

### Playback

When the Home Screen is open and playback is stopped, press the **play** (▶) button to start playback.

### ■ Pausing

When the Home Screen is open and a file is playing back, press the **stop** (■) [**HOME**] button to pause playback at the current position.

### ■ Stopping

When the Home Screen is open and a file is playing back, press the **stop** (■) [**HOME**] button to pause playback, and press the **stop** (■) [**HOME**] button to return to the beginning of the file.

### ■ Rewinding and fast-forwarding (search)

When the Home Screen is open and a file is playing back or stopped, press and hold the ◀◀ or ▶▶ button to rewind or fast-forward and search the playback file.

### ■ Changing the playback position

When the Home Screen is open and playback is stopped or paused, turn the **DATA** dial to change the playback position.  
Playback will be paused after the position is changed.

## Selecting files for playback (skipping)

When the Home Screen is open, press the ◀◀ and ▶▶ buttons to select the file for playback.

If you press the ◀◀ button when the playback position is located at the middle of a file, it will return to the beginning of that file. If you press the ◀◀ button when located at the beginning of a file, the playback position will skip to the beginning of the previous file.

If you press the ▶▶ button when located at the beginning of or middle of a file, the playback position will skip to the beginning of the next file.

## Menu structure

You can make various settings with the **PLAY SETTING** item on the **MENU** screen.

### PLAY SETTING

AREA	Set the file selection area
	ALL FILES, FOLDER
REPEAT	Set the repeat mode
	CONTINUOUS, SINGLE,
	1 REPEAT, ALL REPEAT
JUMPBACK	Set jump-back playback
	OFF, 1–10sec, 20sec, 30sec

---

## Quick Operations

---

### QUICK button overview

The **QUICK** button provides convenient access to functions according to the situation.

Screen	State	Quick menu contents
Home Screen	Stop/ Pause	Delete/divide file, level align, playback EQ and mic input gain
	Playback	Level align, playback EQ and mic input gain
	Recording Standby/ Recording	Mic input gain
BROWSE screen		Operations for the selected file of folder
MENU screen, OTHERS screen, Other settings screens		No function
MIXER screen		Mic input gain

---

## Connecting with a Computer

---

You can transfer audio files on the SD card in the unit to a computer, as well as transfer audio files from the computer to the unit.

---

### Connecting with a computer using USB

1. Use the included USB cable to connect the unit to a computer. If the power is off, turn it on.
2. On the USB SELECT screen, select STORAGE, and press the ► button to connect this unit to the computer. "USB connected" will appear on the display.
3. This unit appears on the computer screen as an external volume named "DR-60DMK2."

---

### Exchanging files with a computer

Click the "DR-60DMK2" drive on the computer screen to show the "MUSIC" and "UTILITY" folders.

To transfer files to the computer, open the "MUSIC" folder and drag and drop the desired files to destinations of your choice.

To transfer files from the computer, drag and drop the audio files on the computer that you want to the "MUSIC" folder.

---

## Disconnecting from a computer

Before disconnecting the USB cable, use the proper procedures for the computer to unmount this unit. The power turns off after the unit completes its shutdown process.

See the computer's operation manual for instructions about how to unmount an external volume.

---

## Settings and Information

---

### System Settings

Use the SYSTEM menu to make various settings to use the unit as you like. You can also initialize settings and format SD cards, for example.

1. Select MENU → OTHERS → SYSTEM and press the ► button.
2. Make the necessary settings using the various functions.

## Quick reference for using various functions

- Button names are shown like this: **MENU**.
- Instructions are abbreviated. For example, On the Home Screen, press the **MENU** button, select the **REC SETTING** menu, and then select the **PRE REC** item becomes: Home Screen → **MENU** → **REC SETTING** → **PRE REC**.
- Not all steps are given for complex operations. For detailed operation procedures, see the Reference Manual.

Category	Desired action	Function name	Procedures, buttons used and explanation
Basic functions	Return to the Home Screen		<b>stop (■) [HOME]</b> Return to the Home Screen if you become unsure about how to proceed.
	Record		Home Screen → <b>record (●)</b> → <b>record (●)</b> Recording will start using the current settings.
	Play back a recording		Home Screen → <b>play (▶)</b> Play the file shown (selected).
	Adjust the playback volume		<b>PHONES</b> volume, <b>CAMERA OUT (HIGH)/LINE OUT</b> volume Adjust the volume of headphones, speakers, etc.
	Select a file for playback		Home Screen → <b>◀◀</b> and <b>▶▶</b> If there a many files, using the browse function might be more convenient.
Recording	Change the file format		Home Screen → <b>MENU</b> → <b>REC SETTING</b> → <b>FORMAT</b> Set the recording file format to BWF, WAV, etc.
	Using the low-cut filter	Low cut filter	Home Screen → <b>MENU</b> → <b>INPUT SETTING</b> → <b>LOW CUT</b> This function removes noise and other sounds at low frequencies. Set the cutoff frequency.
	Set the input gain		Home Screen → <b>MENU</b> → <b>INPUT SETTING</b> → <b>GAIN</b> Set the input gain.
	Adjust the input level manually		Home Screen → <b>RECORD</b> → <b>1/L, 2/R 3-4</b> Watch the meters and set the recording level so that they do not peak.
	Adjust the input level automatically	Limitter	Home Screen → <b>MENU</b> → <b>INPUT SETTING</b> → <b>LIMITER</b> This function compresses only loud sounds to prevent overloads and does not change the recording level.
Other recording features	Add a mark during recording	Mark	Recording Screen → <b>DATA</b> This function adds a mark to the file that can be used as an index during playback.
	Create a new file manually while recording	Manual track incrementation	Recording Screen → <b>▶▶</b> Use this function if you want to create a new file without interrupting recording when, for example, the song changes.

Category	Desired action	Function name	Procedures, buttons used and explanation
Other recording features	Set automatic file division	Automatic track incrementation	Home Screen → <b>MENU</b> → REC SETTING → SIZE This function can be used to automatically create a new file when the set size is reached.
	Start recording a moment before pressing RECORD	Pre-recording	Home Screen → <b>MENU</b> → REC SETTING → PRE REC When the unit is in recording standby, this function allows the unit to record a few seconds before the record button is pressed.
	Delay the start of recording	Recording delay	Home Screen → <b>MENU</b> → REC SETTING → REC DELAY Use this function to delay the start of recording for about 0.3 seconds after the <b>record (●)</b> button is pressed (delay time is fixed).
	Use the self-timer to record	Self-timer	Home Screen → <b>MENU</b> → REC SETTING → SELF TMR This self-timer function is convenient when you want to record your own performance.
	Add a slate tone		When recording → <b>SLATE</b> You can add slate tones whenever you like to files being recorded.
Other playback features	Enable repeat playback	Repeat playback	Home Screen → <b>MENU</b> → PLAY SETTING → REPEAT This function allows you to repeat playback of a specific file.
	Use the playback equalizer	Playback equalizer	Home Screen → <b>QUICK</b> → PLAY EQ This function allows you to increase or decrease the levels of the high or low frequencies during playback to improve the sound quality.
	Go back a few seconds during playback and play that part again	Jump-back playback	During playback → <b>play (▶)</b> When used during playback, this function allows you to go back and play the preceding few seconds again.
	Change the jump-back playback settings	(Jump-back playback)	Home Screen → <b>MENU</b> → PLAY SETTING → JUMPBACK You can set how many seconds to go back when using the jump-back playback function.
	Even out the volume during playback	Level alignment	Home Screen → <b>QUICK</b> → LEVEL ALIGN This function makes recordings sound more even by adjusting the playback volume according to volume during playback.
	Set the playback file area		Home Screen → <b>MENU</b> → PLAY SETTING → AREA You can select a folder or playlist as the play area from which files can be chosen.
File operations	Check file information		Home Screen → <b>MENU</b> → BROWSE → DATA → <b>QUICK</b> → INFO Use this function to check the date of recording and file size, for example.
	Delete a file		Home Screen → <b>MENU</b> → BROWSE → DATA → <b>QUICK</b> → DELETE You can delete files that you do not need.
	Delete a file		Home Screen → <b>QUICK</b> → DELETE You can delete files that you do not need.

Category	Desired action	Function name	Procedures, buttons used and explanation
File operations	Delete all files in a folder at the same time		Home Screen → <b>MENU</b> → BROWSE → DATA → QUICK → ALL DEL You can delete all the files in a folder at the same time.
	Divide a file	Divide	Home Screen → <b>QUICK</b> → DIVIDE Use this function to divide one file into two files.
Unit settings	Set the date and time		Home Screen → <b>MENU</b> → OTHERS → DATE/TIME Use this function to set the internal clock, which is used for the recording dates written to files, for example.
	Turn plug-in power on		Home Screen → <b>MENU</b> → SYSTEM → PLUGIN POWER Use this setting when a mic connected to jack 3 or 4 requires plug-in power.
	Check information about the unit and the card.		Home Screen → <b>MENU</b> → OTHERS → INFORMATION Use this function to check the unit firmware version and the amount of remaining space on the card, for example.
	Change the automatic power saving setting	Automatic power saving	Home Screen → <b>MENU</b> → OTHERS → SYSTEM → AUTO PWR SAVE This function automatically turns the unit off when it is not used for some time.
	Change the backlight setting		Home Screen → <b>MENU</b> → OTHERS → SYSTEM → BACKLIGHT Use this to change the display backlight setting.
	Adjust the display contrast		Home Screen → <b>MENU</b> → OTHERS → SYSTEM → CONTRAST Use this to set the contrast of the characters on the display.
	Set the battery type		Home Screen → <b>MENU</b> → OTHERS → SYSTEM → BATTERY TYPE Select the type of battery being used. This setting affects the accuracy of the remaining battery display.
	Set the Phantom power voltage		Home Screen → <b>MENU</b> → OTHERS → SYSTEM → PHANTOM VOLT
	Restore the unit to its default settings	Initialize	Home Screen → <b>MENU</b> → OTHERS → SYSTEM → INITIALIZE Use this function to restore all settings to their factory defaults.
	Quickly format an SD card	Quick format	Home Screen → <b>MENU</b> → OTHERS → SYSTEM → QUICK FORMAT Use this function to format cards. You should usually use the quick format function to format a card.
	Completely format an SD card	Full format	Home Screen → <b>MENU</b> → OTHERS → SYSTEM → FULL FORMAT Use this only when you want to completely erase the data on a card.
Set the file name format		Home Screen → <b>MENU</b> → OTHERS → FILE NAME You can change the characters used in the file names that are automatically assigned.	

## Message

The following is a list of the pop-up messages that might appear on the DR-60DMKII under certain conditions.

Refer to this list if one of these pop-up messages appears and you want to check the meaning or determine a proper response.

If the error message continues to appear frequently, please contact the store where you purchased this unit or a TASCAM customer support service.

Message	Meaning and response
Battery Empty	The batteries are almost out of power. Replace the batteries.
Can't Divide	The position selected for divide is not suitable (too close to the beginning or end of a file).
Card Error	The SD card could not be handled properly. Change the card.
Card Full	The SD card has no remaining capacity. Erase unnecessary files or move them to a computer to make open space.
Dup File Name	The DIVIDE function would cause the file name to be the same as that of an existing file in the same folder. The DIVIDE function adds "a" or "b" to the end of the file name. Before choosing the DIVIDE function, connect the unit to a computer and edit the file name.
File Full	The total number of folders and files exceeds 5000. Erase unnecessary folders and files or move them to a computer.
File Name ERR	The DIVIDE function would cause the file name to exceed 200 characters. The DIVIDE function adds "a" or "b" to the end of the file name. Before choosing the DIVIDE function, connect the unit to a computer and edit the file name to less than 198 characters.
File Not Found	The file either cannot be found or could be damaged. Check the file using a computer.
File Not Found Make Sys File	The system file is missing. This unit requires a system file for operation. When this message appears, press the <b>DATA</b> dial to automatically create a system file.
File Protected	The file is read only and cannot be erased.

Message	Meaning and response
Format Error Format CARD	The SD card might not be formatted properly or its might be broken. This message also appears if the card was formatted using a computer connected by USB and if an unformatted card is inserted in the unit. Always use the DR-60DMKII to format cards to be used with it. Change the card or press the <b>DATA</b> dial while this message is being shown to format the card. <b>Formatting an SD card will erase all the data on it.</b>
Invalid Card Change Card	Something might be wrong with the SD card. Change the SD card.
Invalid SysFile Make Sys File	The system file required to operate this unit is invalid. When this message appears, press the <b>DATA</b> dial to automatically create a system file.
Layer too Deep	Folders can be created down to two layers. You cannot create a new folder inside the current folder.
Max File Size	The file is larger than the designated size
MBR Error Init CARD	The SD card might not be formatted properly or its might be broken. Change the card or press the <b>DATA</b> dial while this message is being shown to format the card. <b>Formatting an SD card will erase all the data on it.</b>
No Audio File	There is no playback file, so DIVIDE cannot be executed.
No Card	No SD card is in the unit. Install a recordable SD card.
No PB File	There is no file that can be played back. The file might be damaged.
Non-Supported	The audio file is not a supported format. Please see "9 – Connecting with a Computer" in the Reference Manual for file formats that this unit can use.
Switched To Internal Battery	The power supply has switched from USB bus power to the batteries inside the unit.
Write Timeout	Writing to the SD card timed out. Backup files on the card to a computer, and format the card.

If any other error occurs, turn the unit off and restart it.

---

## Troubleshooting

---

If you are having trouble with the operation of this unit, please try the following before seeking repair. If these measures do not solve the problem, please contact the store where you purchased this unit or TASCAM customer support service.

### ■ The unit will not turn on.

- Confirm that the batteries are not dead.
- Confirm that the batteries are installed with the correct ⊕/⊖ orientation.
- Confirm that the AC adapter (TASCAM PS-P520E, sold separately) is securely connected to both the outlet and the unit.
- When using USB bus power, confirm that the USB cable is securely connected.
- When using USB bus power, confirm that it is not connected via a USB hub.
- Confirm that the HOLD switch is not set in the direction of the arrow.

### ■ The unit turns off automatically.

- Is the automatic power saving function on? See "Setting the automatic power saving function" in "10 – Settings and Information" of the Reference Manual.
- Since this unit complies with the European Standby Power Regulations (ErP), the automatic power saving function operates regardless of whether the unit is being powered by an AC adapter or batteries. If you do not want to use the automatic power saving function, set it to "OFF". (The factory default setting is "30min".)

### ■ The unit does not function.

- **Confirm that the HOLD switch is not set in the direction of the arrow.**
- Is the unit connected to a computer by a USB cable? (Does "USB connected" appear on the display?)

### ■ The SD card is not recognized.

- Confirm that the SD card is inserted completely.

### ■ Playback does not work.

- If you are trying to play a WAV file, confirm that the sampling frequency is supported by this unit.

### ■ No sound is output.

- Check the connections with the monitoring system.
- Is the volume of the monitoring system minimized?
- Is the OUTPUT LEVEL setting of the unit minimized?

### ■ Recording does not work.

- If you are using an external device, check the connection again.
- Check the input settings again.
- Confirm that the input level is not too low.
- Confirm that the SD card is not full.
- Confirm that the number of files has not reached the maximum that the unit can handle.

### ■ The input level is low.

- Confirm that the input level setting is not too low.
- Confirm that the output level of any connected device is not too low.

### ■ The sound I am trying to record sounds distorted.

- Is the input level set too high?

### ■ The playback sounds unnatural.

- Check the playback equalizer setting.
- Is the level align function active?

### ■ I cannot erase a file.

- Confirm that you are not trying to erase a file that has been copied from a computer after being write-protected.

### ■ This unit's files do not appear on the computer.

- Confirm that the unit is connected to the computer using its USB port.
- Confirm that USB hubs are not used.
- Confirm that the unit is not recording or in recording standby mode.



---

## Specifications

---

### Ratings

#### Recording media

SD card (64MB – 2GB)  
SDHC card (4GB – 32GB)

#### File system

WAV: 44.1/48/96 kHz, 16/24-bit  
BWF (Broadcast Wave Format): 44.1/48/96 kHz, 16/24-bit

#### Number of channels

4 channels (stereo x 2)

---

### Inputs and outputs

#### 1/L connector, 2/R connector (phantom power supported)

Connector: XLR-3-31, 6.3mm (1/4") standard TRS Jack

#### 3-4 jack (supports plug-in power)

Connector: 3.5mm (1/8") stereo mini jack

#### CAMERA IN jack

Connector: 3.5mm (1/8") stereo mini jack

#### CAMERA OUT (LOW) jack

Connector: 3.5mm (1/8") stereo mini jack

#### PHONES jack

Connector: 3.5mm (1/8") stereo mini jack

#### CAMERA OUT (HIGH)/LINE OUT jack

Connector: 3.5mm (1/8") stereo mini jack

### USB jack

Connector: USB Mini-B Type  
Format: USB 2.0 HIGH SPEED mass storage class

### REMOTE jack

Connector: 2.5mm TRS Jack

---

### Audio performance

#### Frequency response

20-20kHz +0.5/-2dB (LINE IN or MIC IN to LINE OUT, Fs44.1k/48kHz, JEITA)  
20-40kHz +0.5/-3dB (LINE IN or MIC IN to LINE OUT, Fs96kHz, JEITA)

#### Distortion

0.02% or less (LINE IN or MIC IN to LINE OUT, Fs44.1k/48k/96kHz, JEITA)

#### S/N ratio

92dB or more (LINE IN or MIC IN to LINE OUT, Fs44.1k/48k/96kHz, JEITA)

#### Equivalent input noise

-120dBu or more (Note) JEITA: Conforming to JEITA CP-2150

---

### Recording times

File format (recording setting)		SD/SDHC card capacity
		4 GB
WAV/BWF 16bit (STEREO)	44.1kHz	6:44:00
WAV/BWF 24bit (STEREO)	96kHz	2:04:00

- The recording times shown above are estimates. They might differ depending on the SD/SDHC card in use.
- The recording times shown above are not continuous recording times, but rather they are the total possible recording times for the SD/SDHC card.
- If recorded in mono in WAV files, the maximum recording time will be double the figures above.
- For dual and 4-channel recording in WAV/BWF format, the recording times are about half those shown above.

## Requirements for connected computers

Check the TEAC Global Site (<http://teac-global.com/>) for the latest information about supported operating systems.

## Supported operating systems

Windows XP, Windows Vista, Windows 7, Windows 8 (including 8.1)  
Mac OS X 10.2 or newer

## General

### Power

Four AA batteries (Alkaline or Ni-MH)  
USB bus power supplied from a computer  
AC adaptor (TASCAM PS-P520E, sold separately)  
External battery pack designed for this unit (TASCAM BP-6AA, sold separately)

### Power consumption

5.4W (maximum)

### Battery operation time (continuous operation)

- Using alkaline batteries (EVOLTA)

Format	Operation time	Note
Recording 2-channel 44.1kHz/16-bit WAV files	About 4:30	MIC input selected (phantom power not used)

- Using NiMH battery (eneloop)

Format	Operation time	Note
Recording 2-channel 44.1kHz/16-bit WAV files	About 5 hours	MIC input selected (phantom power not used)

- When using Ni-MH batteries (eneloop pro)

Format	Operation time	Note
Recording 2-channel 44.1kHz/16-bit WAV files	About 6 hours	MIC input selected (phantom power not used)

## Continuous operating time when using batteries and a TASCAM BP-6AA (sold separately)

- When using Alkaline batteries (EVOLTA) and TASCAM BP-6AA (EVOLTA)

Format	Operation time	Note
Recording 2-channel 44.1kHz/16-bit WAV files	About 10:30	MIC input selected (phantom power not used)

- When using NiMH batteries (eneloop) and TASCAM BP-6AA (eneloop)

Format	Operation time	Note
Recording 2-channel 44.1kHz/16-bit WAV files	About 12 hours	MIC input selected (phantom power not used)

- When using NiMH batteries (eneloop pro) and TASCAM BP-6AA (eneloop pro)

Format	Operation time	Note
Recording 2-channel 44.1kHz/16-bit WAV files	About 14:30	MIC input selected (phantom power not used)

### NOTE

*When using phantom power, the continuous operating time will become shorter depending on the microphone used.*

### Dimensions (W × H × D)

133 x 93.2 x 78mm / 5.24 x 3.67 x 3.07inches (with the top adapter attached)

### Weight

510g (not including batteries)

### Operating temperature range

0°C–40°C (32°F–104°F)

- Illustrations in this manual might differ in part from the actual product.
- Specifications and external appearance might be changed without notification to improve the product.
- Detailed specifications are provided in the Reference Manual.